

8. GSM Antenna Radiation Pattern

GSM Antenna Radiation Pattern

Freq.	XZ Plane	YZ Plane
<p>824 MHz Peak Gain:1.526 dBi</p>		
<p>880 MHz Peak Gain:1.996 dBi</p>		
<p>960 MHz Peak Gain:1.133 dBi</p>		
<p>1710 MHz Peak Gain:1.946 dBi</p>		
<p>1850 MHz Peak Gain:3.0 dBi</p>		

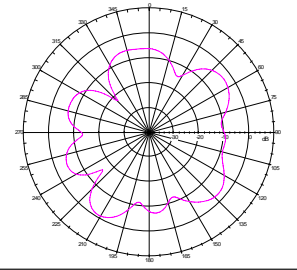
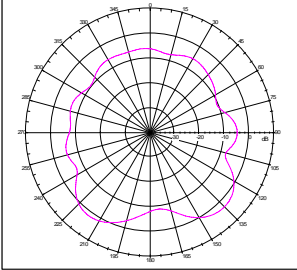
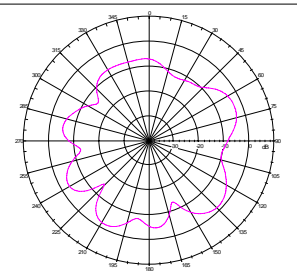
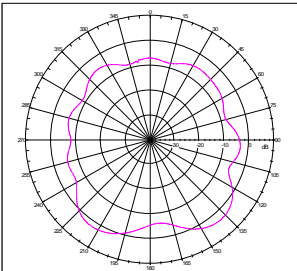
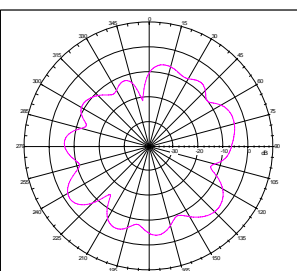
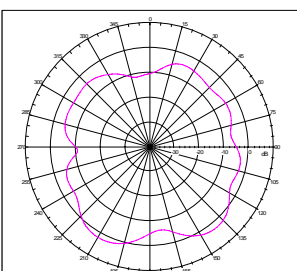
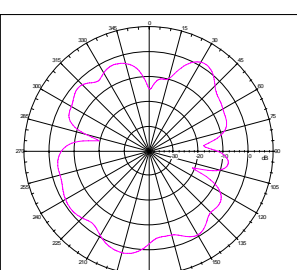
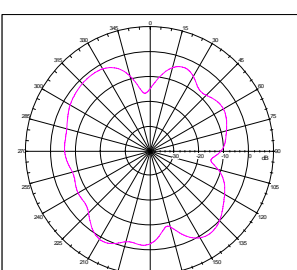
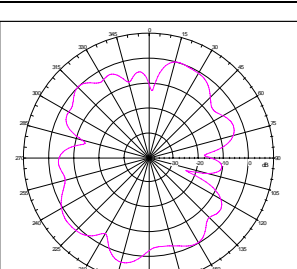
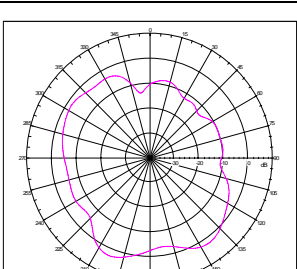
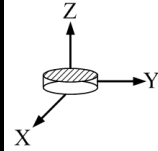

GSM Antenna Radiation Pattern

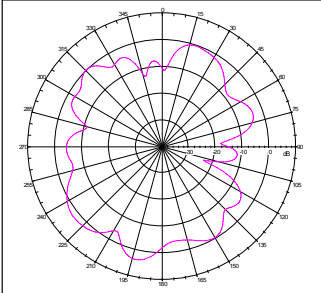
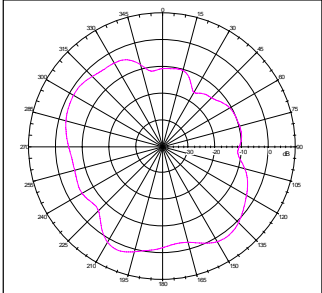
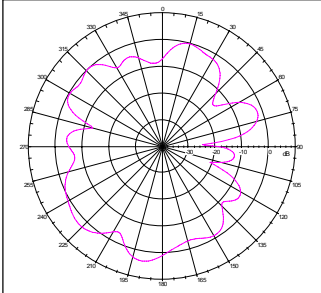
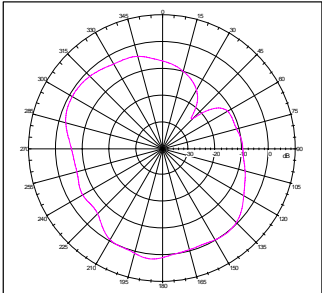
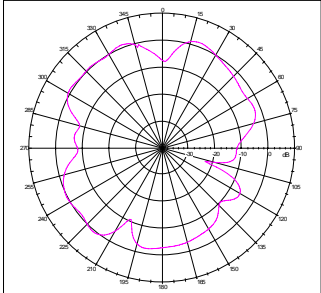
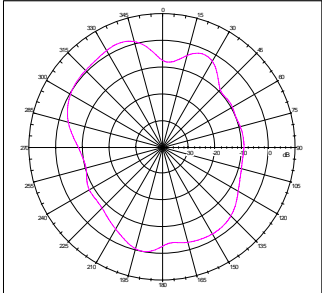
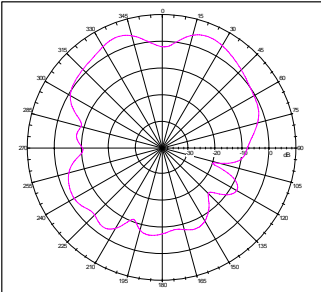
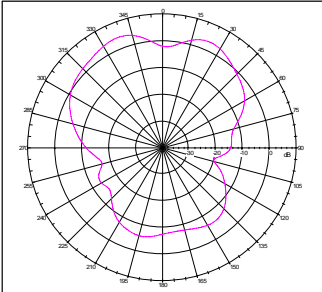
Freq.	XZ Plane	YZ Plane
<p>1880 MHz Peak Gain:3 dBi</p>		
<p>1990 MHz Peak Gain:3.27 dBi</p>		
<p>2110 MHz Peak Gain:3.78 dBi</p>		
<p>2170 MHz Peak Gain:5.82 dBi</p>		

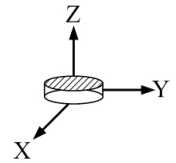

9. Drawing

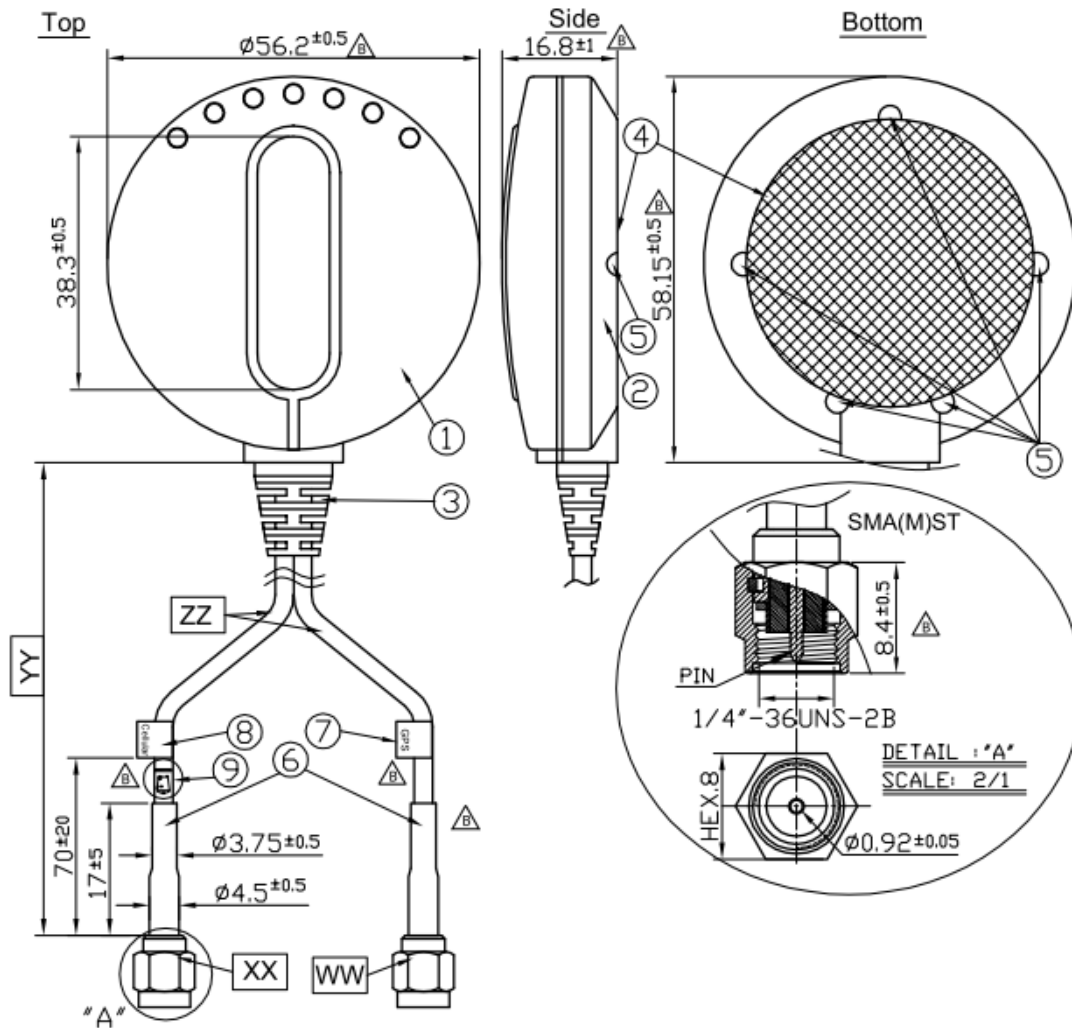

	Name	Material	Finish	Quantity
1	Top Housing	ABS	Black	1
2	Bottom Housing	ABS	Black	1
3	SR	PVC	Black	1
4	Sticker	Matte Silver PET	Silver	1
5	2.6L Screw	Stainless Steel	Clear	5
6	Heat Shrink Tube	PE	Black	2
7	GPS Label	Coated Paper	Orange	1
8	Cellular Label	Coated Paper	Blue	1
9	WEEEE Label	Coated Paper	White	1

10. Packaging

1pcs antenna per small PE bag
80 small PE bag per box

Unit : mm

