

SPECIFICATION

- Part No. : **PC14.03.3000D**
- Product Name : Circular Dual-Band 2.4~5.2GHz PCB antenna with cable and connector
- Feature : \varnothing 42mm*0.8mm
High efficiency antenna for Wi-Fi/ Bluetooth/ ZigBee applications
3M Rg-174 RP-SMA(M)
Stable efficiency, gain and radiation patterns
Cable and Connector fully customizable
RoHS Compliant



1. Introduction

The PC14.03.3000D is a high performance wireless antenna for internal use in Wi-Fi or WLAN equipment worldwide. Omni-directional gain across both bands ensures constant reception and transmission. Its compact size and high performance make it ideal for integration into today's devices.

Many module manufacturers specify peak gain limits for any antennas that are to be connected to that module. Those peak gain limits are based on free-space conditions. In practice, the peak gain of an antenna tested in free-space can degrade by at least 1 or 2dBi when put inside a device. So ideally you should go for a slightly higher peak gain antenna than mentioned on the module specification to compensate for this effect, giving you better performance.

Upon testing of any of our antennas with your device and a selection of appropriate layout, integration technique, or cable, Taoglas can make sure any of our antennas' peak gain will be below the peak gain limits. Taoglas can then issue a specification and/or report for the selected antenna in your device that will clearly show it complying with the peak gain limits, so you can be assured you are meeting regulatory requirements for that module.

For example, a module manufacturer may state that the antenna must have less than 2dBi peak gain, but you don't need to select an embedded antenna that has a peak gain of less than 2dBi in free-space. This will give you a less optimized solution. It is better to go for a slightly higher free-space peak gain of 3dBi or more if available. Once that antenna gets integrated into your device, performance will degrade below this 2dBi peak gain due to the effects of GND plane, surrounding components, and device housing. If you want to be absolutely sure, contact Taoglas and we will test. Choosing a Taoglas antenna with a higher peak gain than what is specified by the module manufacturer and enlisting our help will ensure you are getting the best performance possible without exceeding the peak gain limits.

Cable and connector are fully customizable.

2. Specification

Parameter	Multi-Standard					
Communication System						
Frequency Range (GHz)	2.4	2.45	2.5	5.15	5.25	5.35
VSWR	1.46	1.66	1.60	1.76	1.41	1.48
Return Loss	-14.53	-12.1	-12.66	-11.14	-15.25	-14.18
Impedance	50 Ohms					
Radiation	Omni					
Polarization	Horizontal					
MECHANICAL						
Dimensions	Ø42mm*0.8 mm					
Connector	RP-SMA(M)					
Cable Standard	RG-174					
Weight	33g					
ENVIRONMENTAL						
Operation Temperature	-40 °C ~ +85 °C					
Storage Temperature	-40 °C ~ +85 °C					
RoHS Compliant	Yes					

3. Antenna performance

3.1. Return Loss

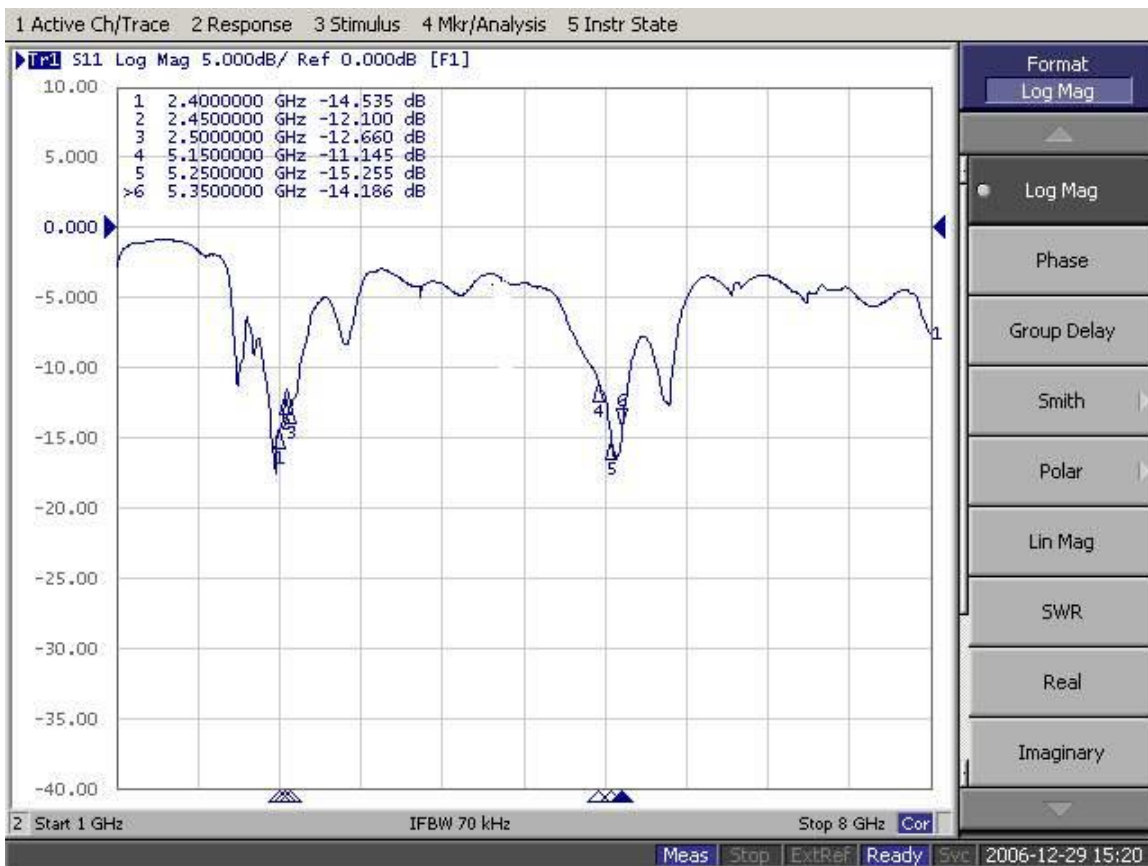

3.2. VSWR

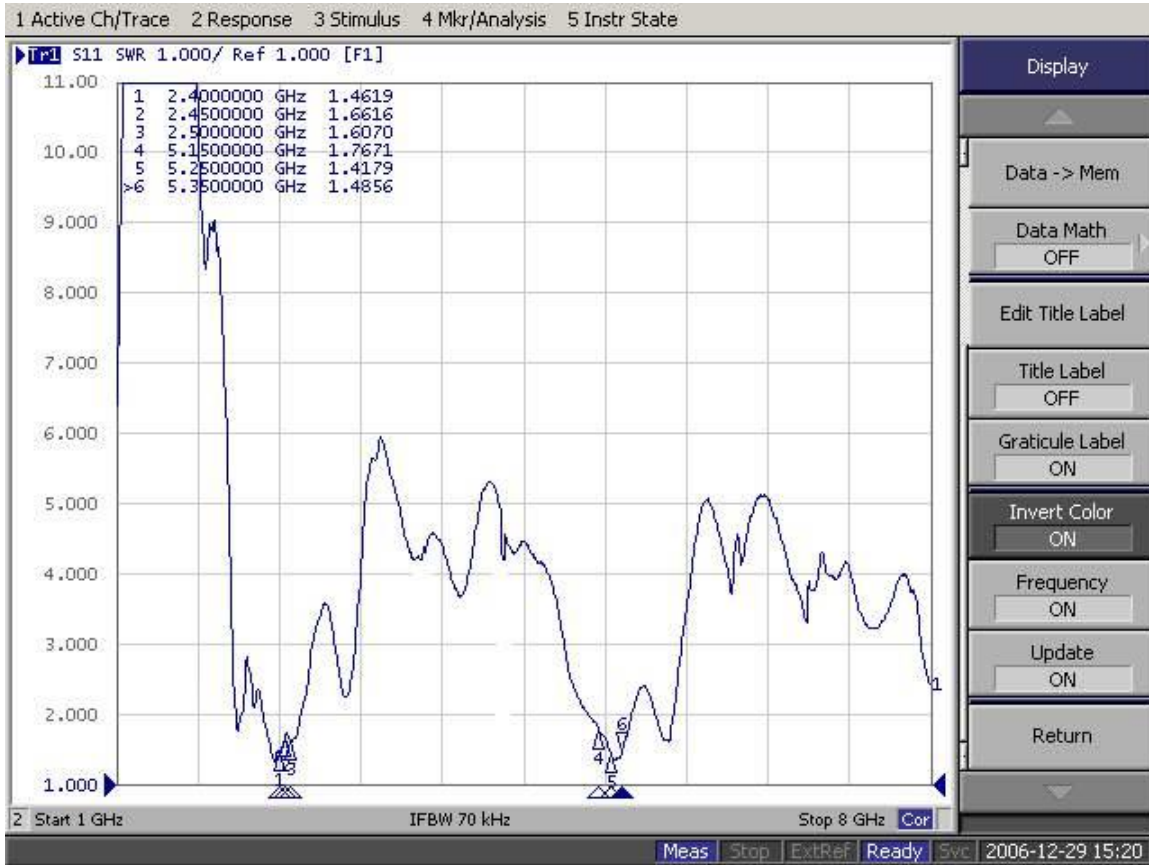

4. Radiation Property

4.1. 3D Radiation Patterns

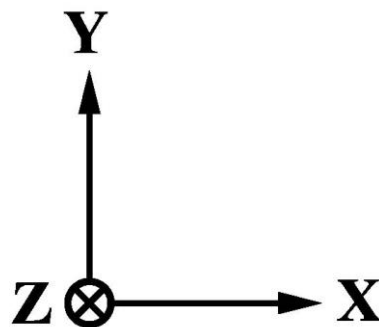



TAOGLAS®

2.4GHz

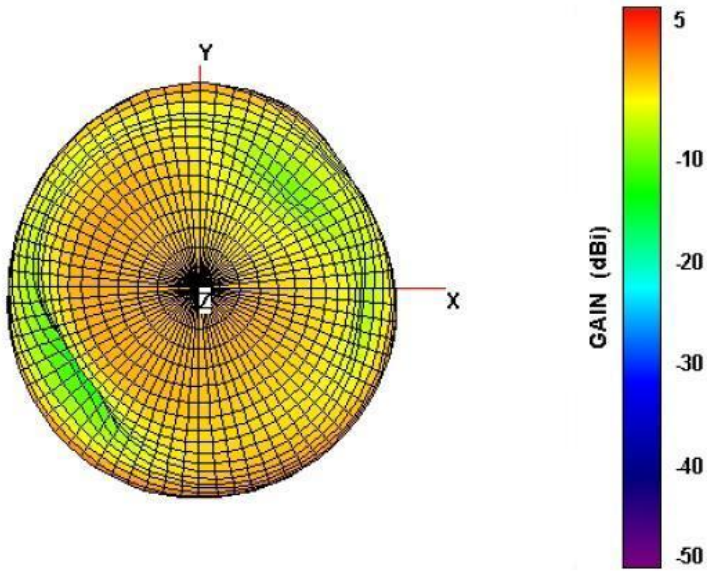

2.45GHz

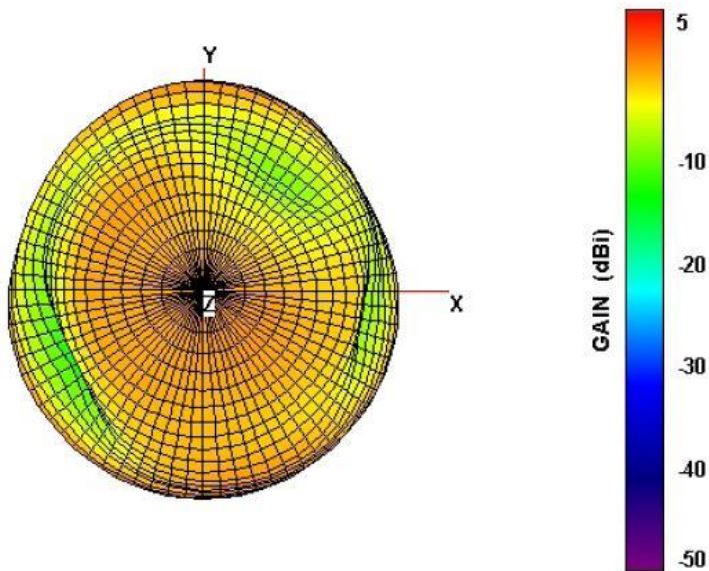



TAOGLAS®

2.5GHz

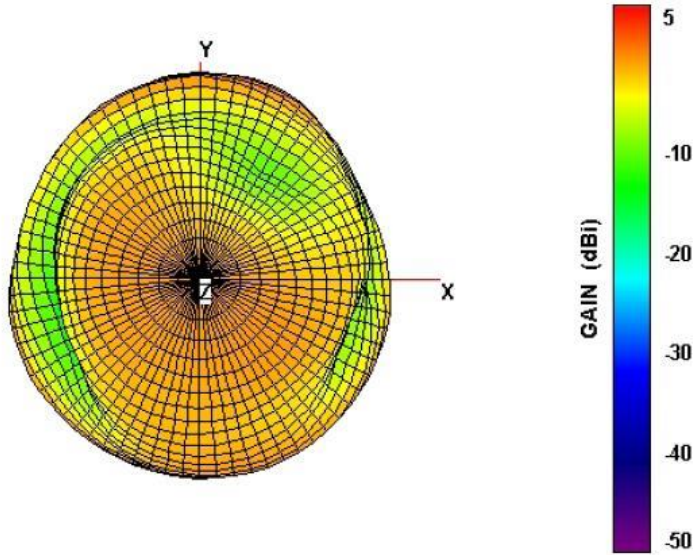

5.15GHz

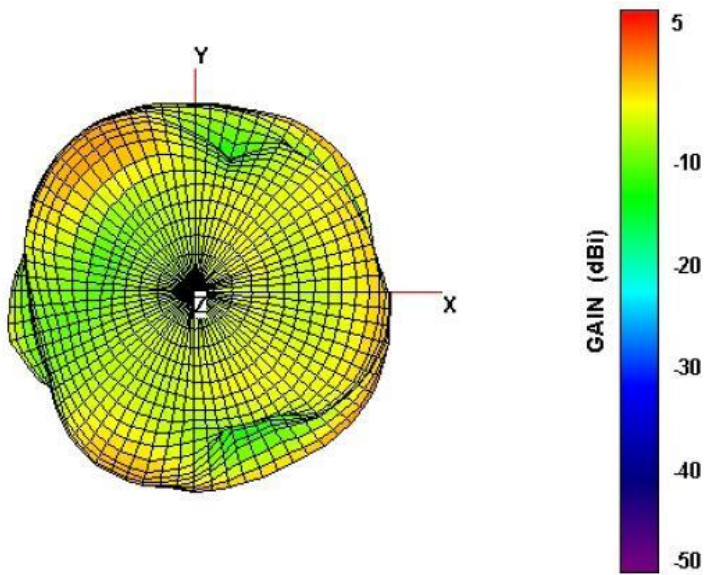



TAOGLAS®

5.25GHz

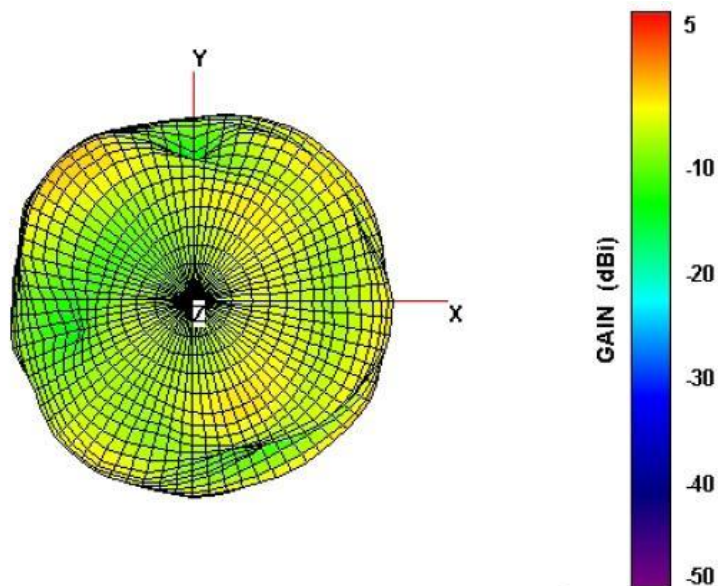

5.35GHz

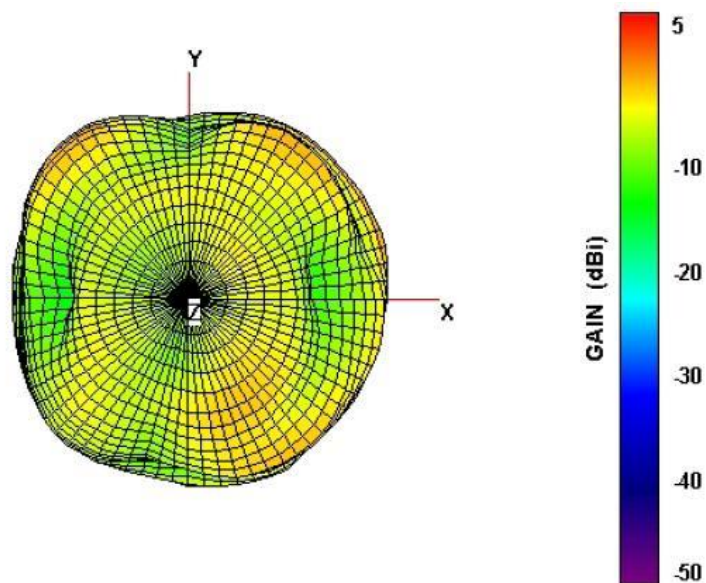

5. Antenna Drawing

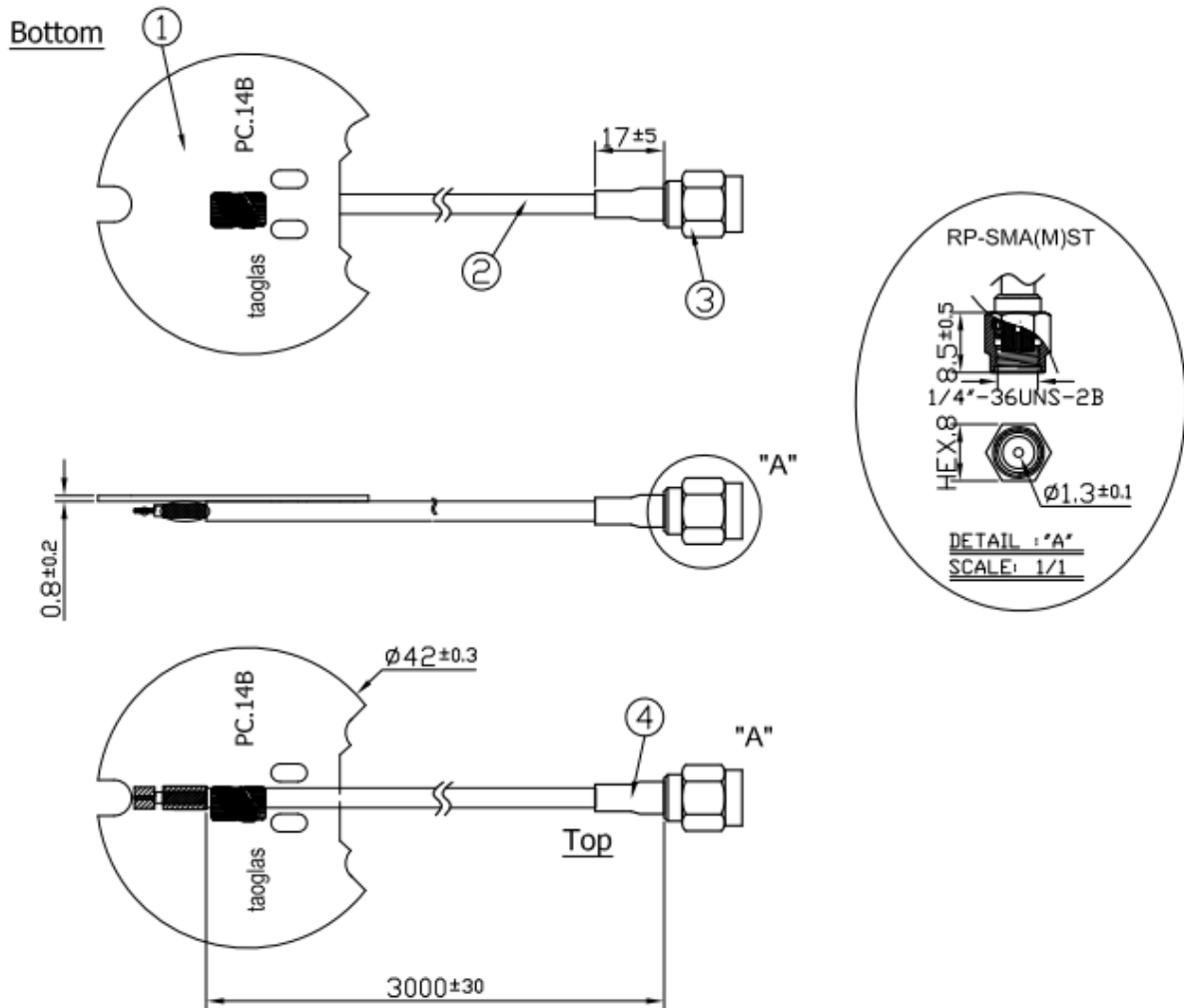

NOTES:

- 1.No dregs or insufficient soldering. Solder thickness 0.3~1.7mm
- 2.The solder must be smooth and full to the edges of the pad.
The solder must not extend outside of the pad area.
- 3.The connector position has special orientation to the PCB as per drawing.
- 4.All material must be RoHS compliant.
- 5.Open/short QC, VSWR required.
- 6.Soldered area. 

	Name	P/N	Material	Finish	QTY
1	PC.14B PCB	PC.14B PCB	FR4 0.8t	Black	1
2	RG174	RG174.AD	PVC	Black	1
3	RP-SMA(M)ST	SMA.M.RP.ST.PLUG.D.AD	Brass	Gold	1
4	Heat Shrink Tube	001311F0000XXA	PE	Black	1